

POSTMASTER[®] +

FENCE SYSTEM



Move To The Next Generation Of Wood Fence Systems



**Save Time
& Money...
Sell More
Projects!**

▶ **What is PostMaster + Fence System**

3 STEEL POSTS - LINE - CORNER - GATE

- Exclusive from Master Halco Inc.

▶ **Why PostMaster +**

- Differentiate Yourself - Make "Innovation & Quality" your brand
- Profitable - Save Time & Money - Sell More Projects
- Versatile - Build traditional or contemporary fence styles
- Strength - Gate post eliminates call backs
- Steel To Steel - The strongest gate hardware connection possible
- Engineered - System designed to withstand 73 mph windload
- Warranty - Limited Lifetime Structural Warranty

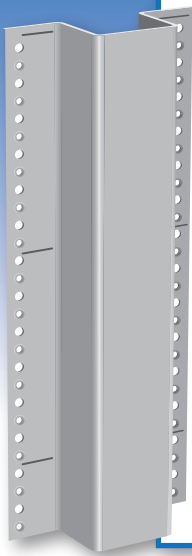

LINE POSTS

- Wider flanges provide stronger holding power and reduces splitting of rails
- Shorter “hat” section allows a flush cover for a clean fence line
- Multiple hole patterns allows for screws or lag bolts
- Countersunk holes for flush seating and ease to cover
- Concrete lock adds system strength and performance

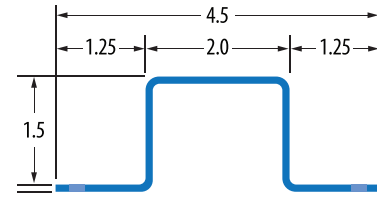

- Material - Pre-Galvanized G90
- A653 SS Grade 50
- Thickness - 0.100 inch
- Yield Strength - 50 ksi
- Tensile Strength - 65 ksi
- Windload - 73 mph (ULT, ASCE 7-10, IBC 2012)
- Concrete Lock

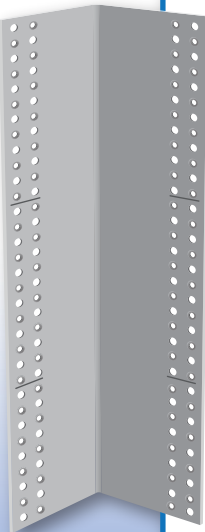

CORNER POSTS

- Strong .120” steel with a concrete lock for the strongest corner that supports 2 lines of fence
- Multiple hole patterns provide options for outside rail or inside rail installation for the style of fence you install

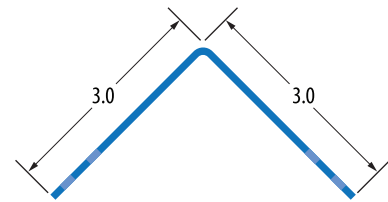

- Material - Pre-Galvanized G90
- A653 SS Grade 50
- Thickness - 0.120 inch
- Yield Strength - 50 ksi
- Tensile Strength - 65 ksi
- Windload - 70 mph (ULT, ASCE 7-10, IBC 2012)
- Concrete Lock



GATE POSTS

- Robust steel design that holds the hardware and gate straight and square for years of worry free service and no call backs
- Rails slide inside the post to maximize holding strength with screws
- Powder coated black finish adds a style accent to the gate or can be covered for the natural look of wood
- Can be used for right or left hung gates or used as a Gate and Latch Post.

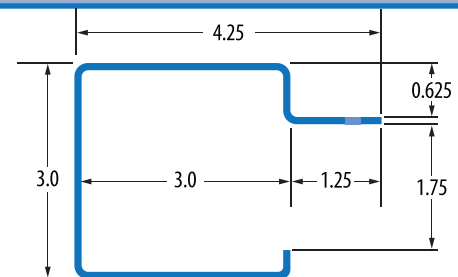

- Material - Powder Coated Black
- A653 SS Grade 50
- Thickness - 0.100 inch
- Yield Strength - 50 ksi
- Tensile Strength - 65 ksi
- Windload - 112.6 mph (ULT, ASCE 7-10, IBC 2012)

AVAILABLE LENGTHS 6' - 7' - 7'6" - 8' - 9' - 10' - 11' - 12'



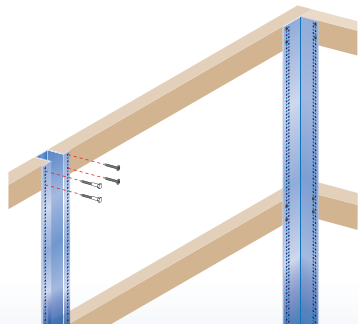
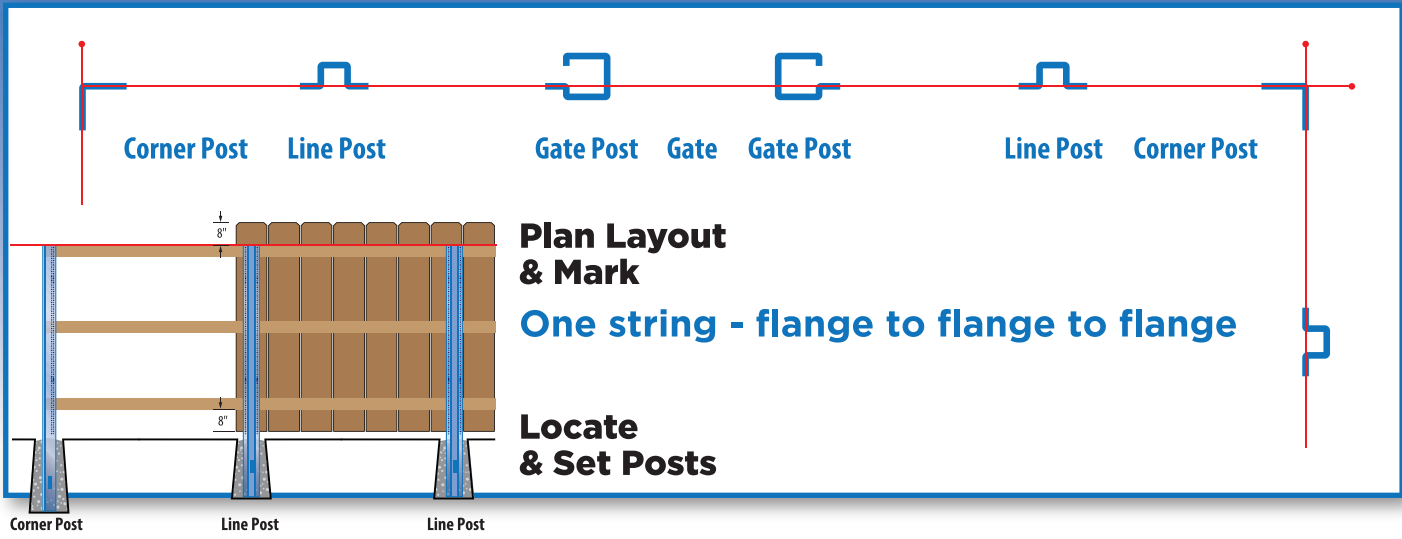

Install Rails

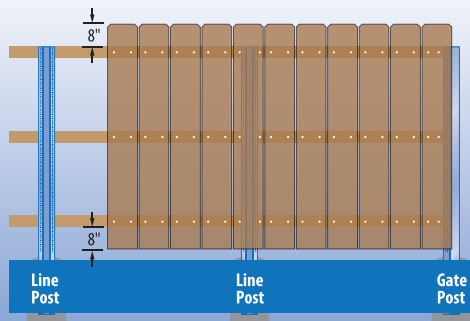

Install Pickets

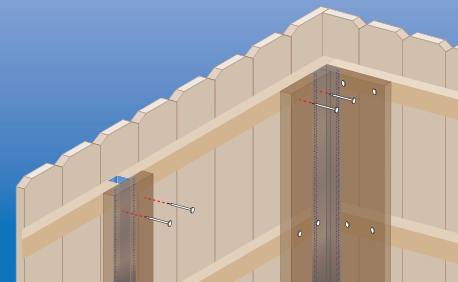

Install Cover Boards

CONTRACTOR'S ▼ BOTTOM LINE ▼

Differentiate Yourself

Enhance your brand awareness

Style Flexibility

Good, Better, Best System

Ease of Installation

Easy to set the fence line, rail height, and install

Strong, Robust Fence System

Lifetime of performance that eliminates call backs

Limited Lifetime Warranty

Selling tool that offers peace of mind for homeowners

Finally A Gate Solution That Makes Sense

Steel Gate Frames
 -Steel to Steel Connection
Eliminate Failure
 -Reduce call backs

The PostMaster+ Fence excels in a wide variety of fence styles

CONSUMERS WILL LOVE

Good Neighbor Fence

Hidden post system highlights the natural beauty of wood

Style Flexibility

They can choose the style of fence

Strong, Durable Fence System

Create secure barrier for family and pets

Robust Galvanized Steel

Will not twist, rot, warp or crack like wood posts

Limited Lifetime Warranty

Peace of mind with their investment



Contact your local Master Halco Sales Associate to learn more about how it takes a family of products to create the best system



*Quality Products,
Exceptional Service,
Outstanding People*

**Chain Link | Ornamental | Vinyl
Wood | Access Controls | Agricultural
888.643.3623 | MasterHalco.com**